

Potter

Fioriera singola con fondo in acciaio fisso o regolabile. Di forma parallelepipedica, Potter è disponibile in svariate misure e materiali tra cui acciaio inox spazzolato o verniciato, lamiera zincata o alluminio verniciati a polvere, acciaio cor-ten. Grazie alle diverse estensioni progettate ad hoc per questo sistema modulare, potrete sempre trovare risposte adeguate alle vostre esigenze funzionali ed estetiche.









Potter
 Versione fioriera singola
 Finitura grigio



Potter



Potter
Versione fioriera singola
Finitura ruggine



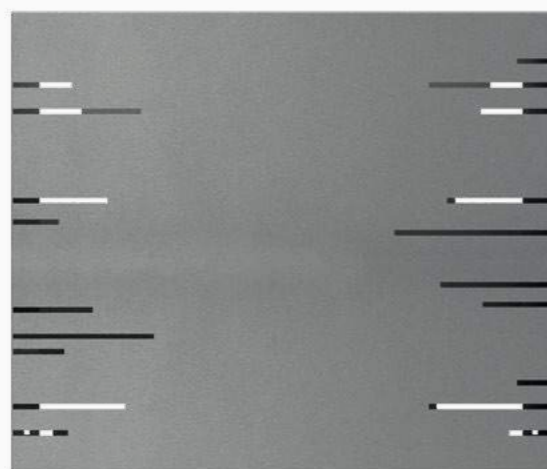
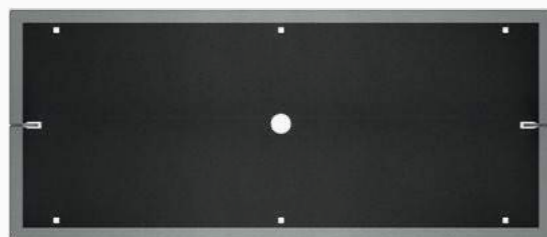

Esempi di tipologie estetiche
Dimensioni su misura

Cod. 010

A

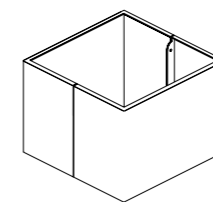

B

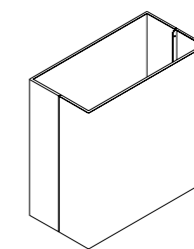

C

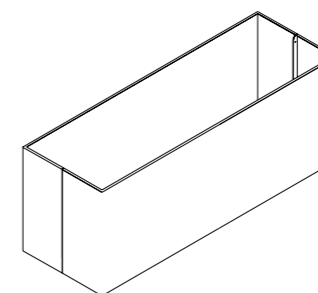

D

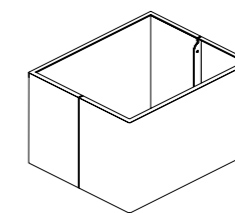

E

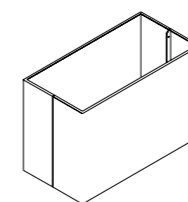

Struttura realizzabile in
 acciaio inox spazzolato
 acciaio inox verniciato
 lamiera zincata verniciata
 a polvere
 alluminio verniciato a polvere
 acciaio cor-ten fornito in uno
 stato avanzato di ossidazione



Colori vernici

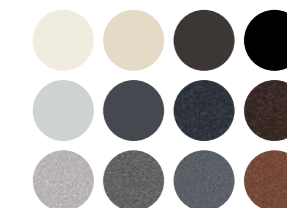

Optional

Zavorra
 Ruote pivotanti

Cod. 010

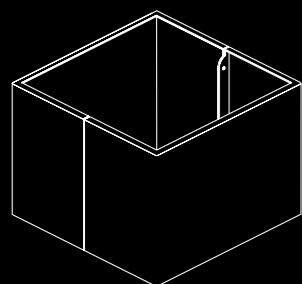

Pergo
p.24

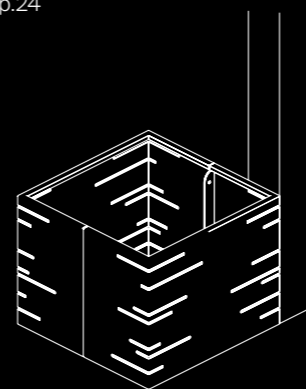

Panco
p.30

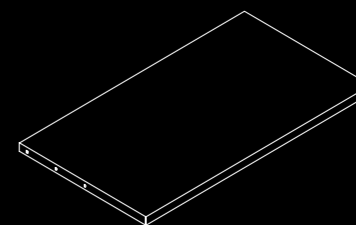

Slim
p.32

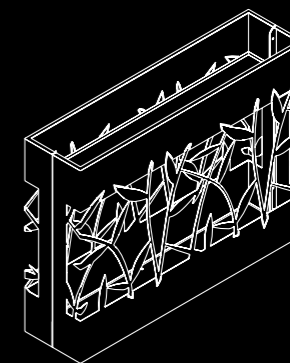

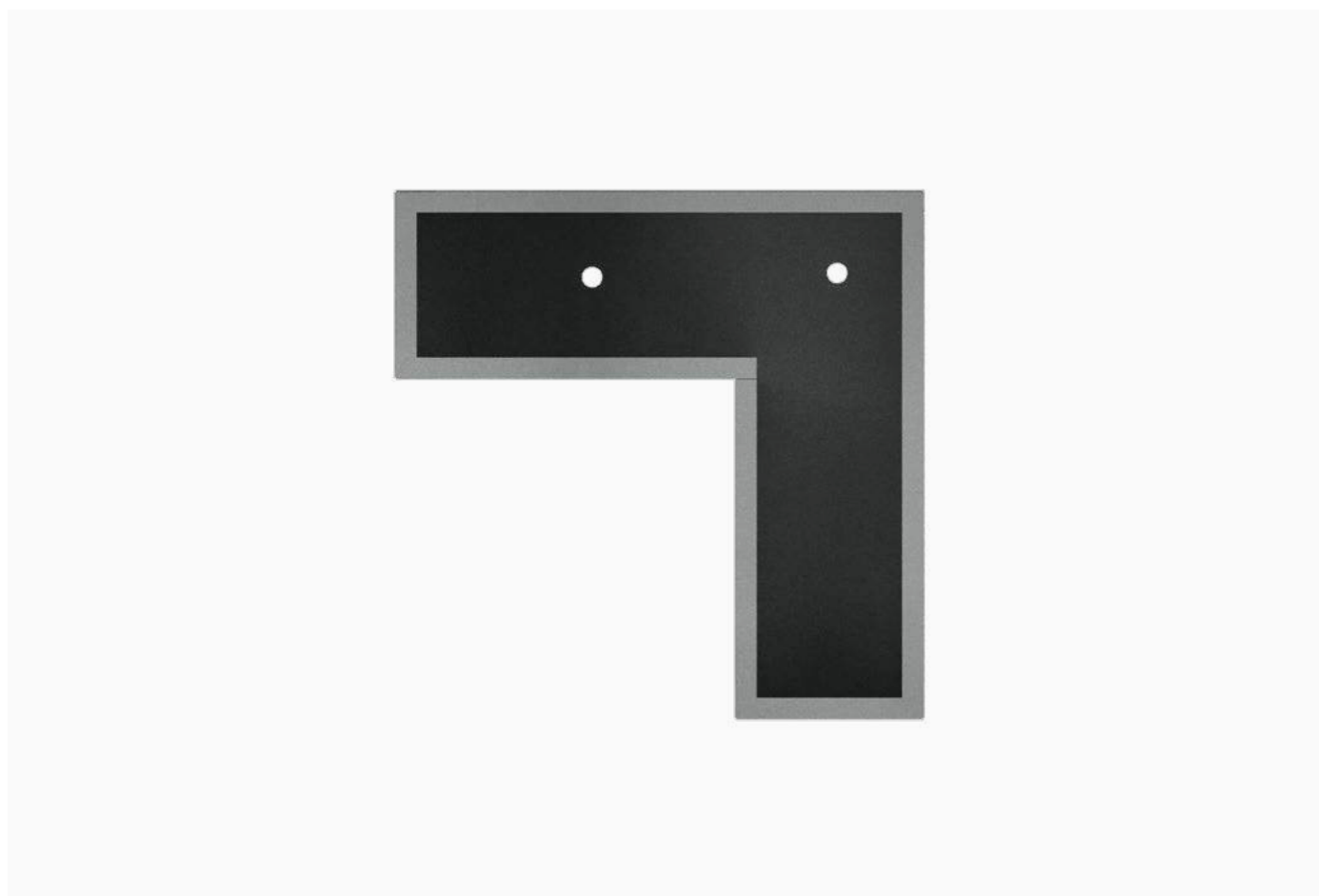

Potter Pergo

Pergo Potter si distingue per il suo decoro lineare e la sua adattabilità a qualsiasi tipo di struttura, dalla pergola al gazebo. La fioriera avvolge o ingloba il palo di sostegno delle coperture. Possono essere forniti vari accessori idonei per il fissaggio al palo.

Potter

Esempi di tipologie estetiche Cod. 020
Dimensioni su misura

A

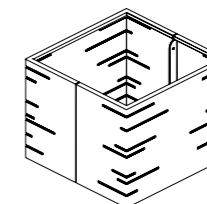

B

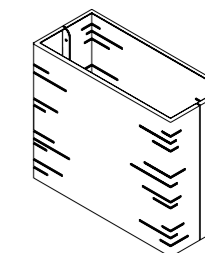

C

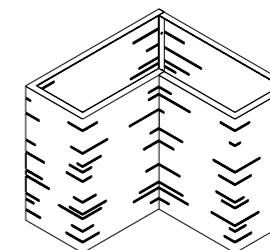

Il palo della pergola viene ancorato esternamente alla fioriera attraverso una piastra di base (A), o in alternativa tramite piastrino (B). L'utilizzo del piastrino consente di avere il palo distaccato dalla fioriera (C).

Nella versione cubica c'è la possibilità di inserire il palo anche internamente alla fioriera, fissandolo al centro (D) o ad uno dei quattro angoli interni della Potter (E).

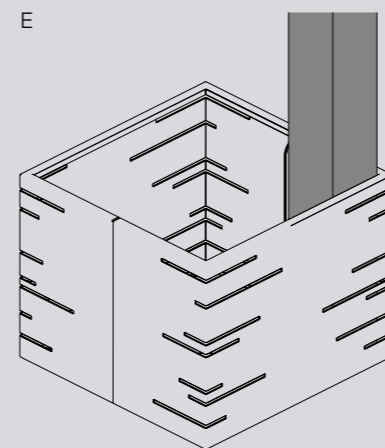
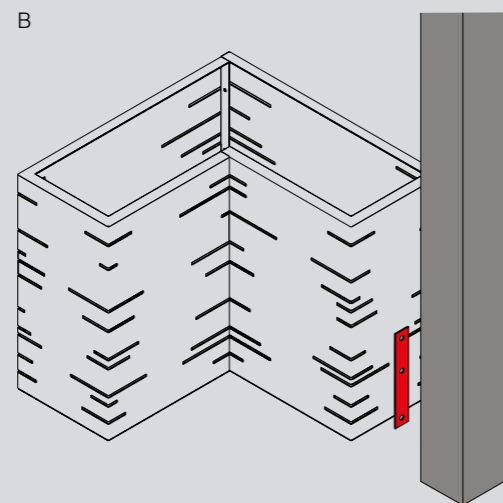
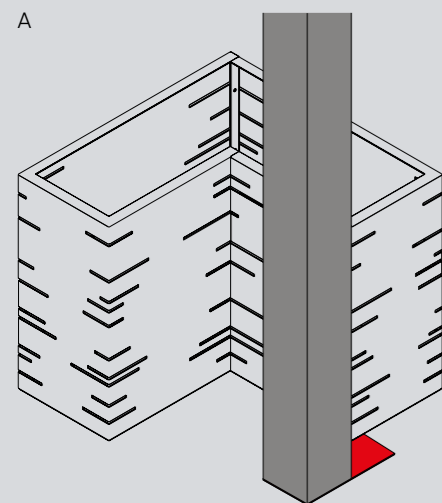
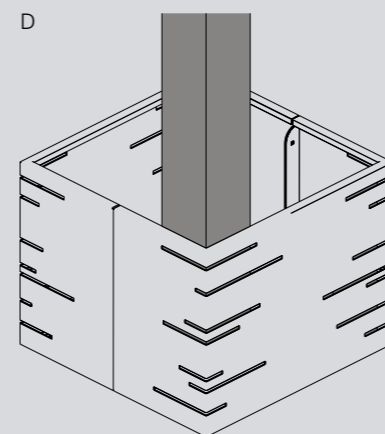
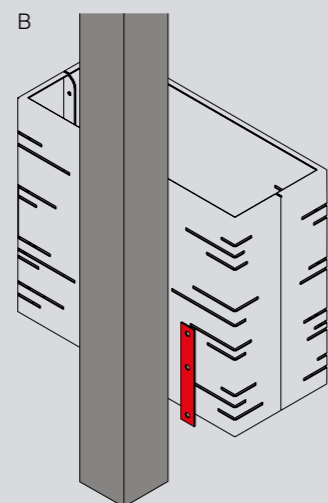
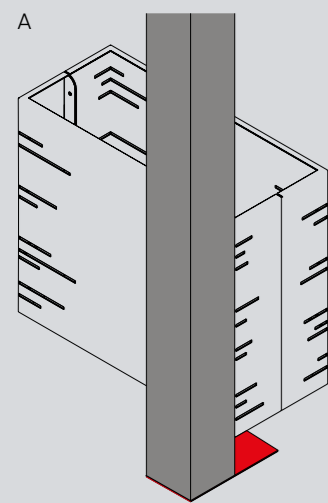
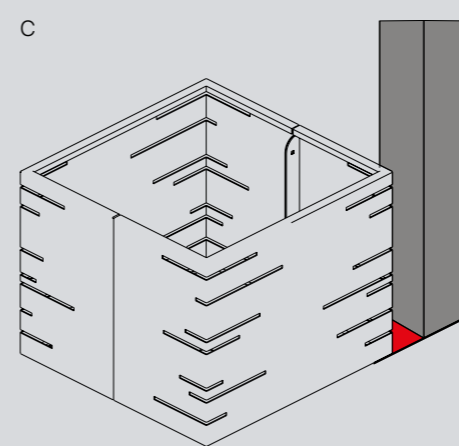
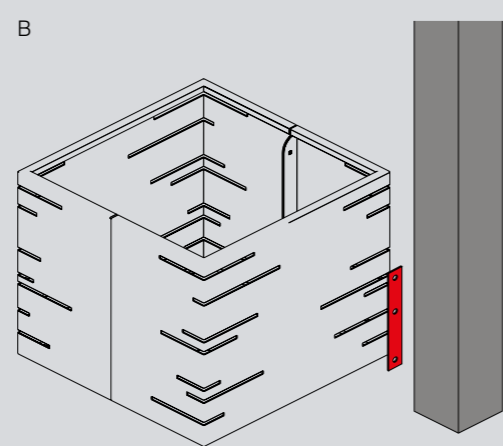
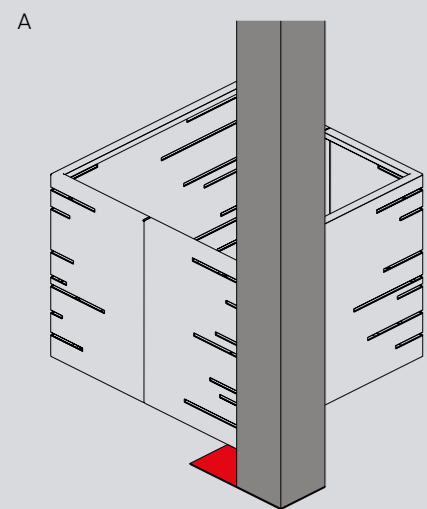

Accessori
Piastra di base
L15 P30

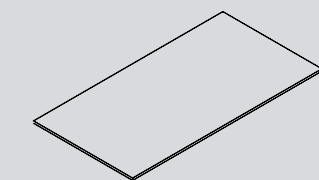

Piastrino
L3 H20

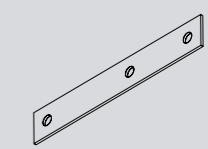

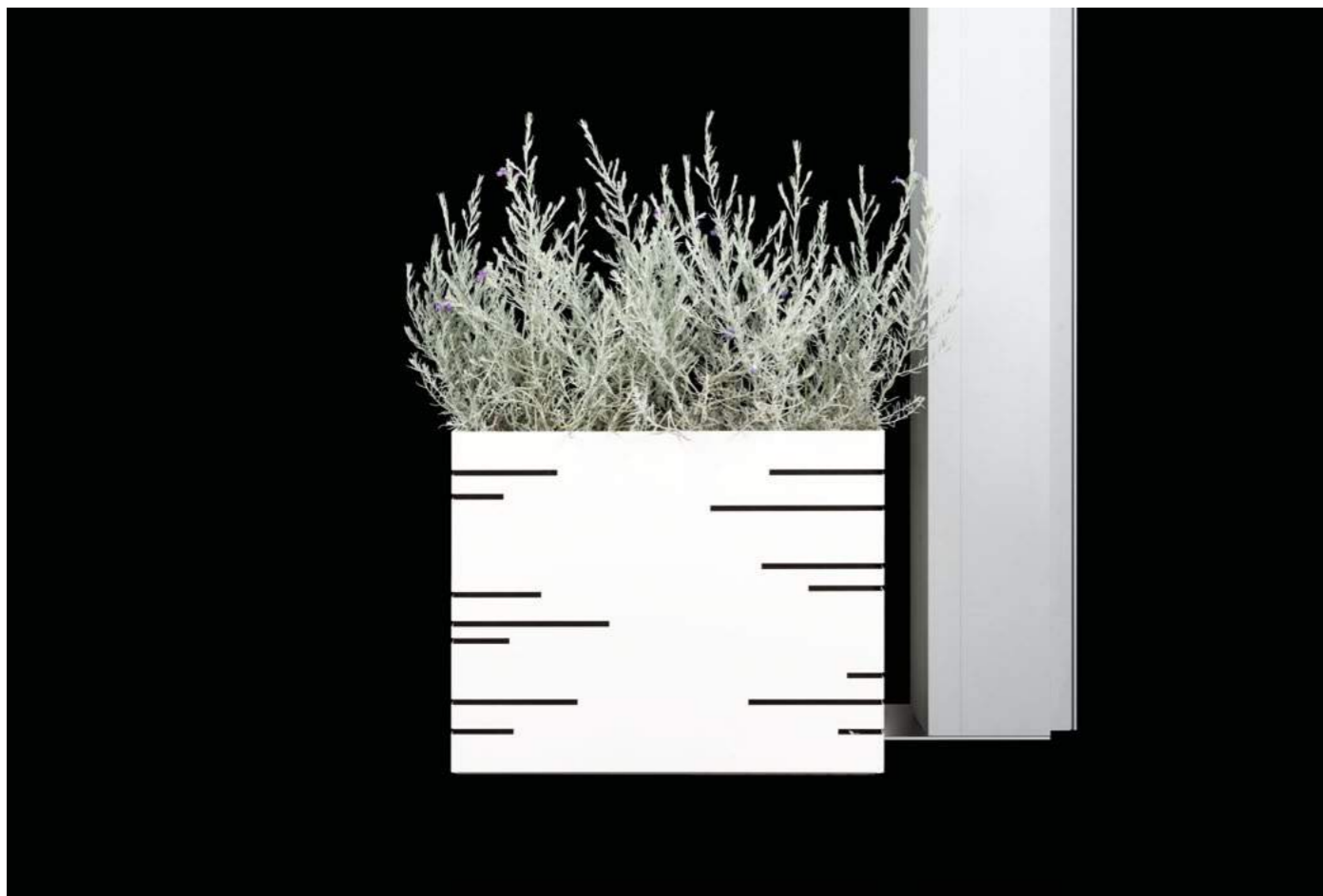
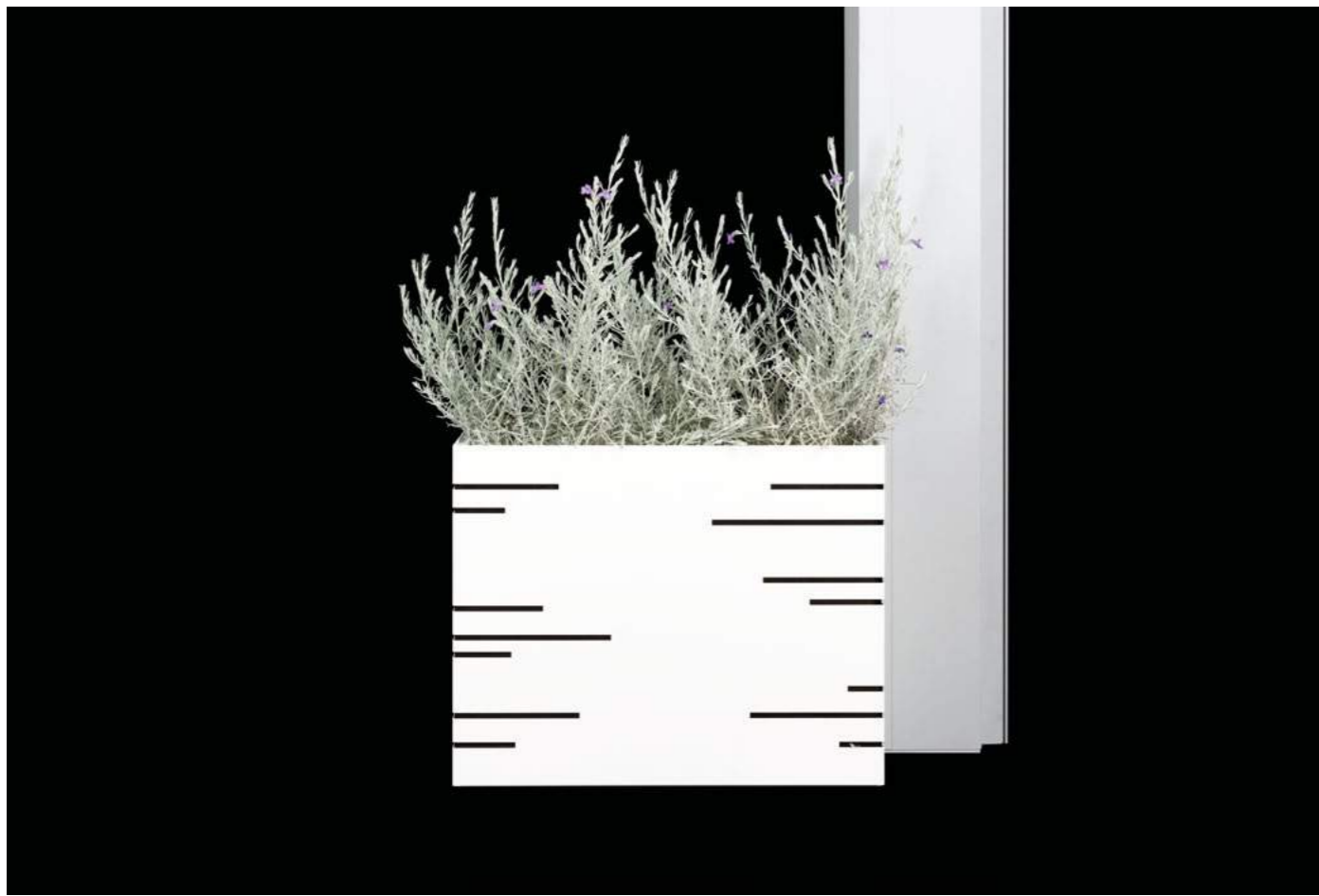

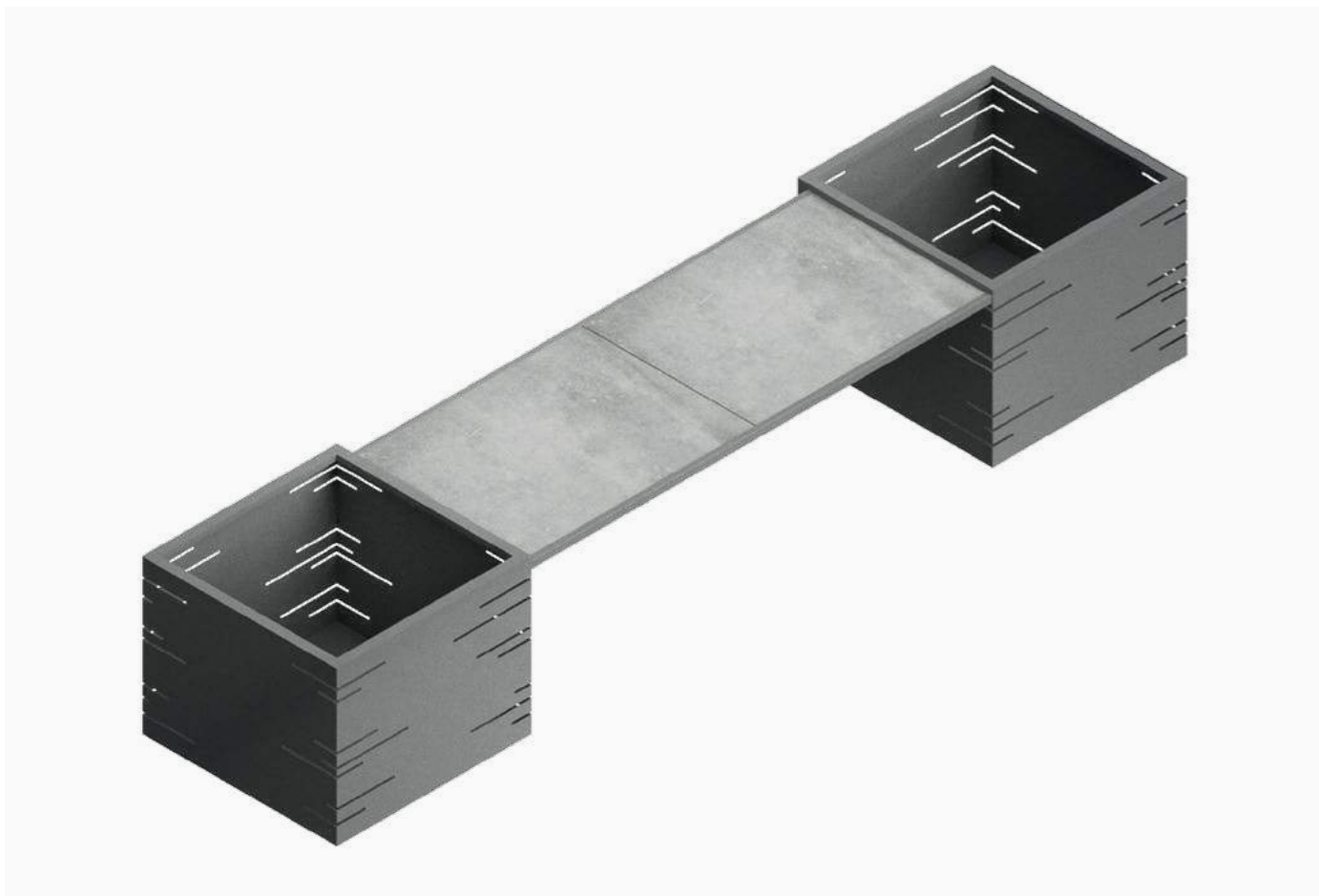
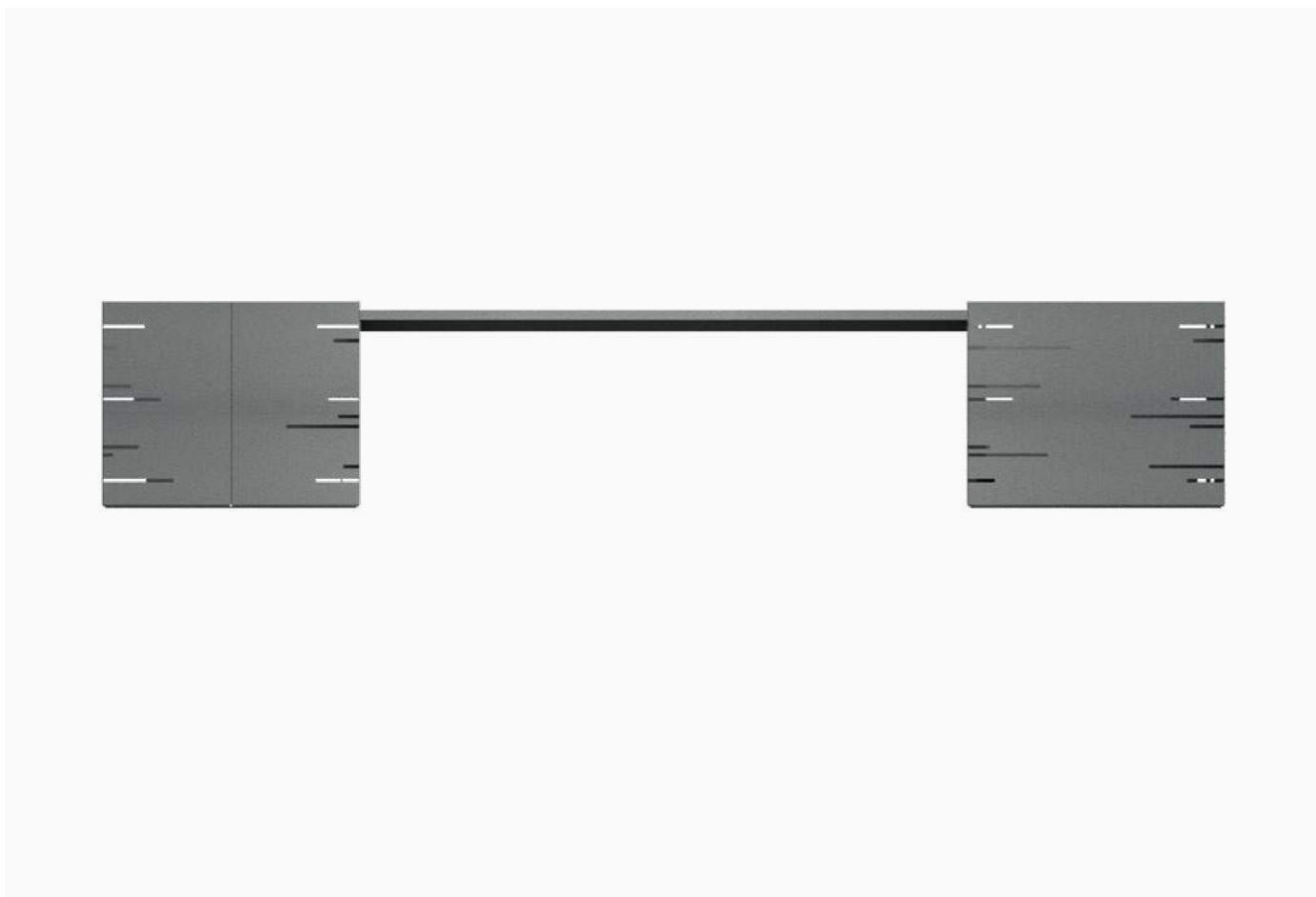

Panco è la seduta in acciaio e grès ideata per le fioriere Potter quadrate o ad angolo. Di forma rettangolare, risulta molto solida e resistente e garantisce una base d'appoggio molto stabile. L'acciaio della seduta è personalizzabile con le stesse finiture delle fioriere a cui è fissata. La finitura delle lastre in grès è scelta in coordinato con il colore dell'acciaio.

Cod. 020

Dimensioni su misura

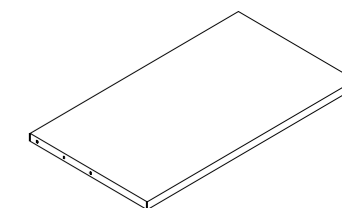

Configurazione finale con due potter

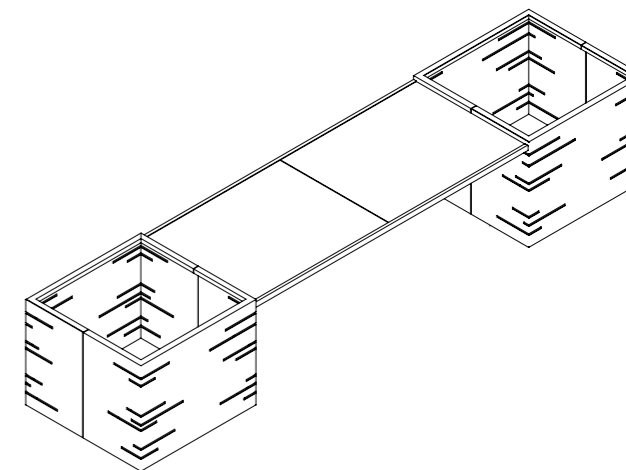

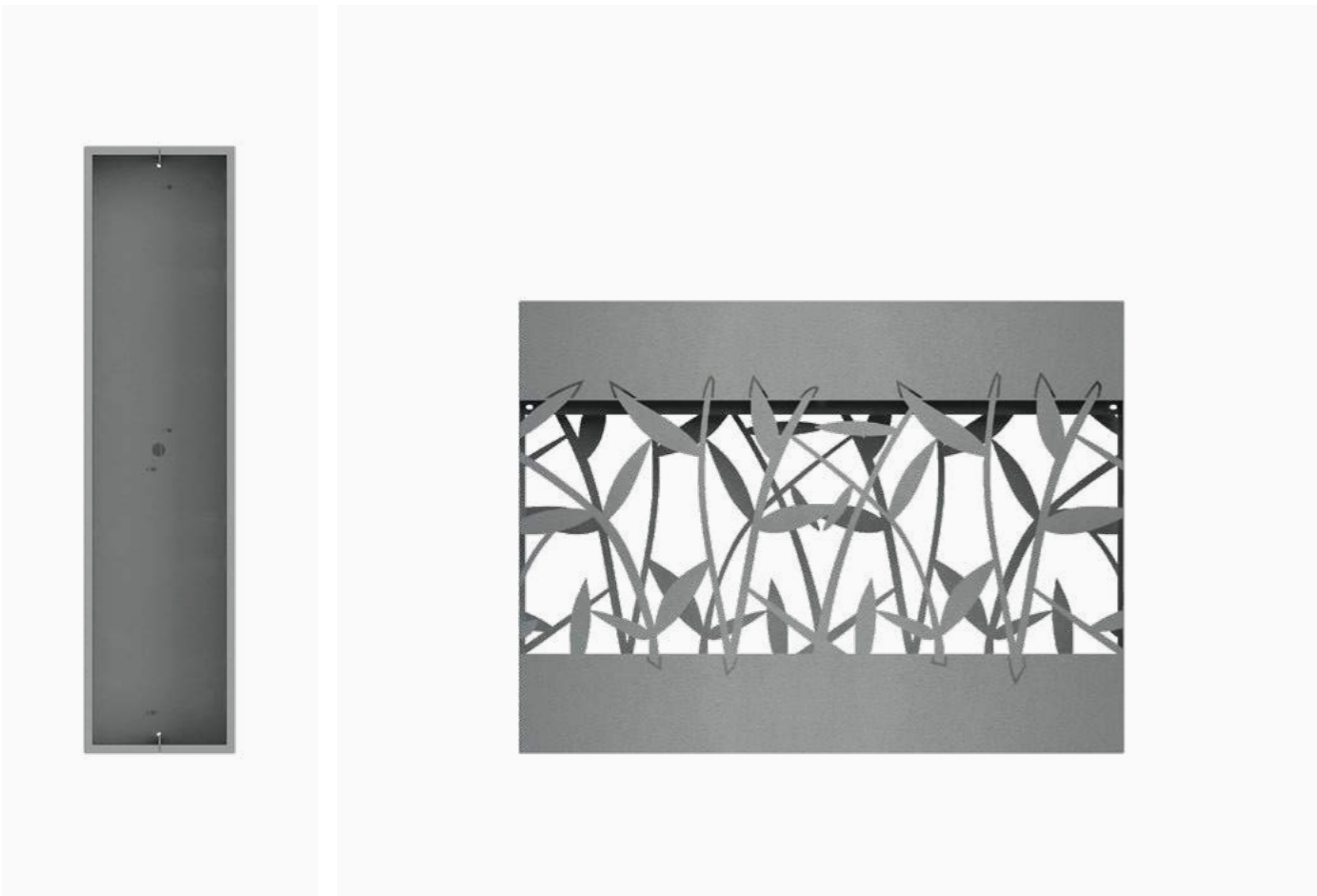

Slim

Slim è una fioriera separè a due livelli in acciaio o alluminio. La struttura, leggera e permeabile alla luce, è caratterizzata dal pattern grafico intagliato. Sono presenti due vasche per accogliere il verde, una alla sommità e una alla base. Grazie ai moduli rettangolari e angolari si possono realizzare composizioni perimetrali complete.

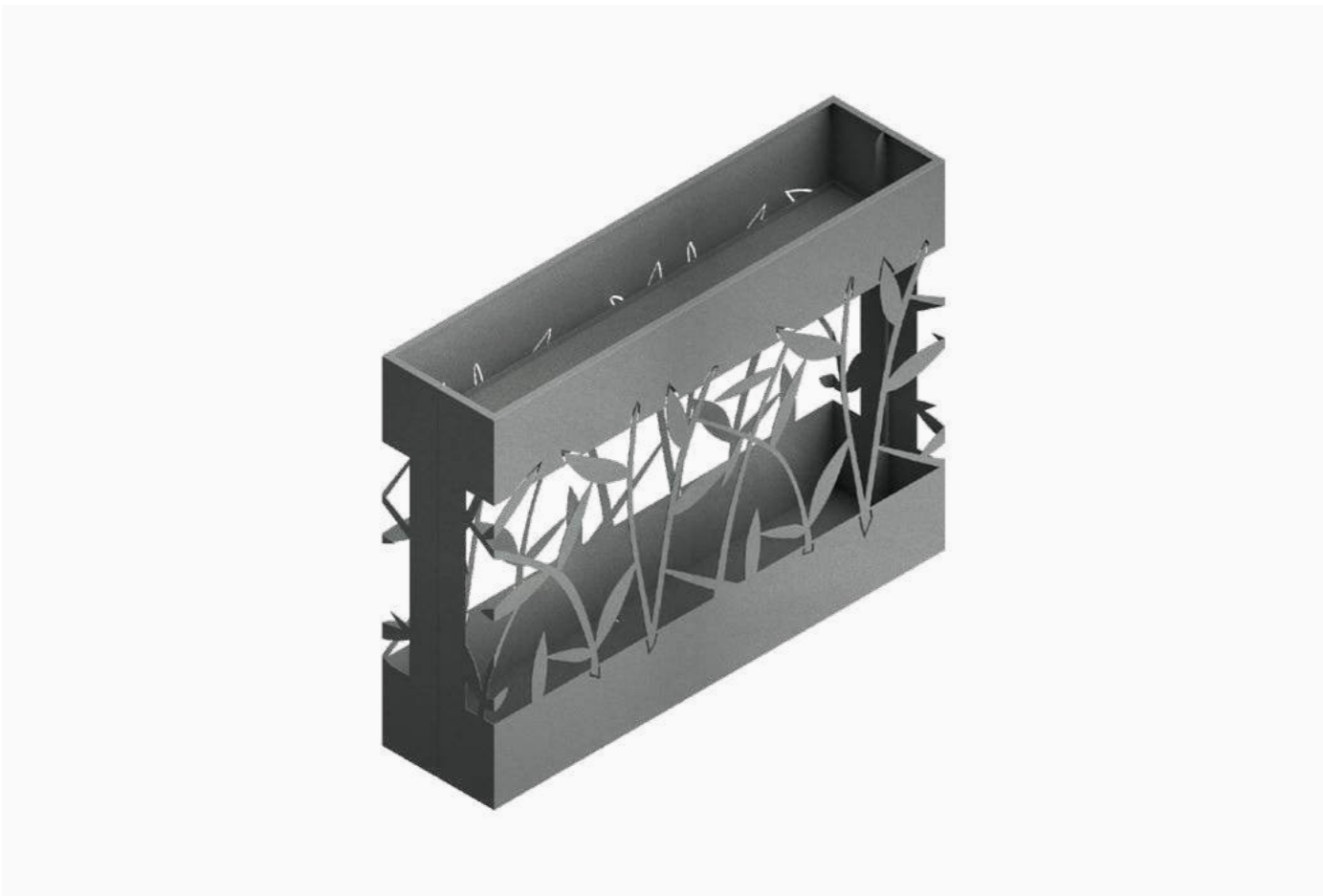

Esempi di tipologie estetiche Cod. 020
 Dimensioni su misura

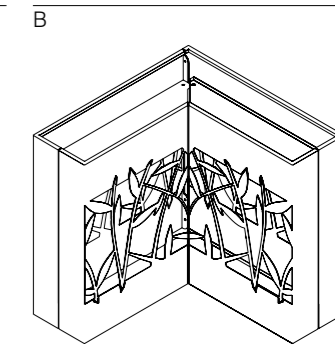
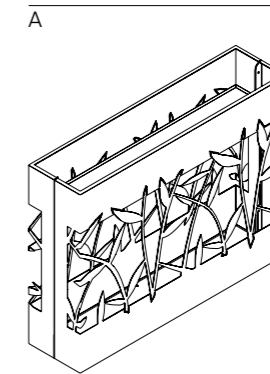

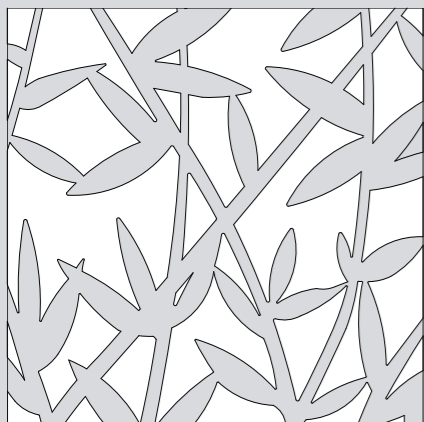

01

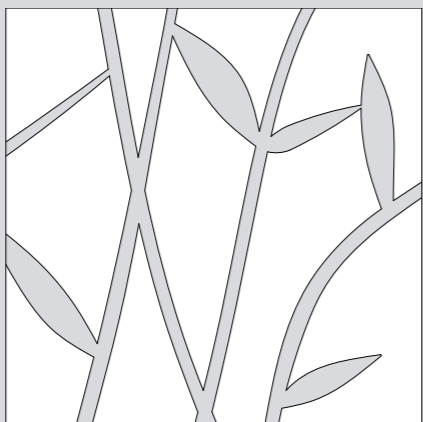

02

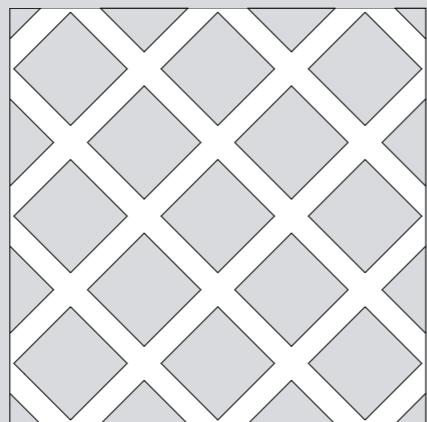

03

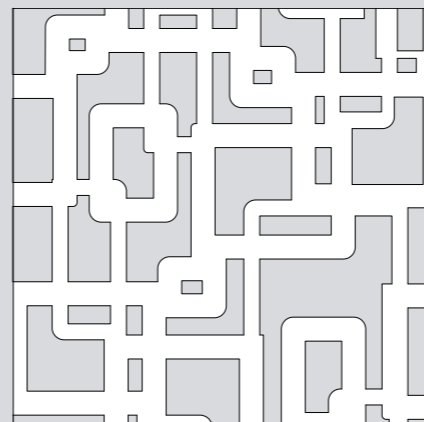

14

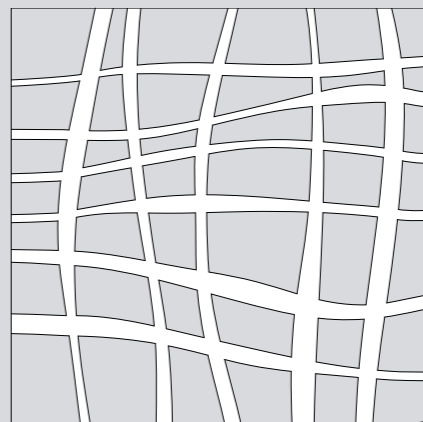

15

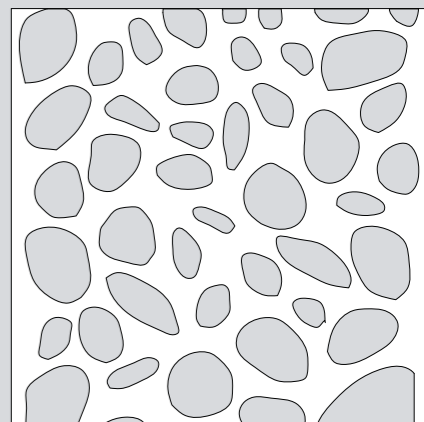

16

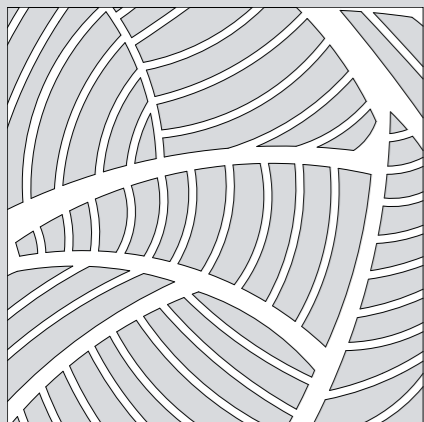

04

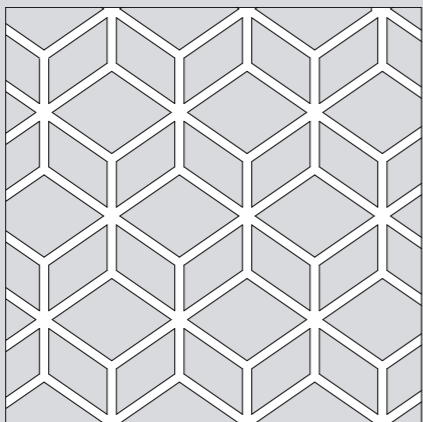

05

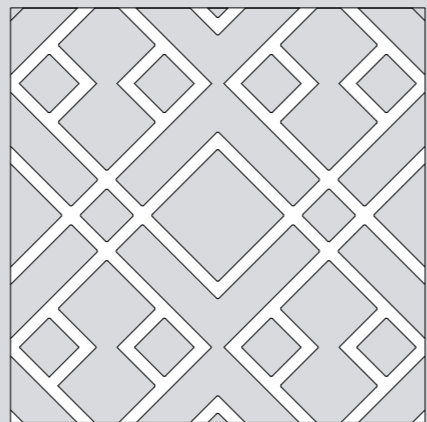

06

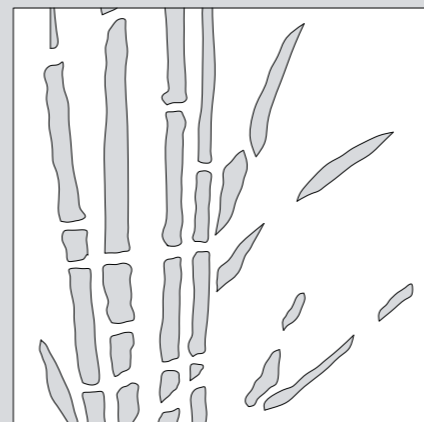

17

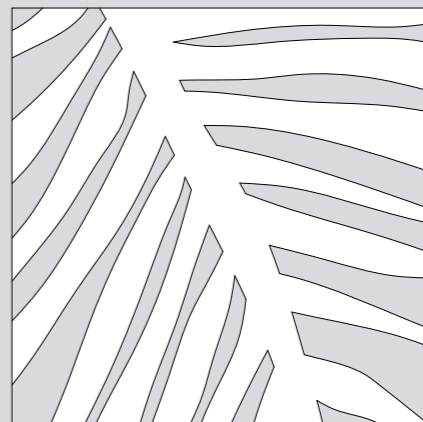

18

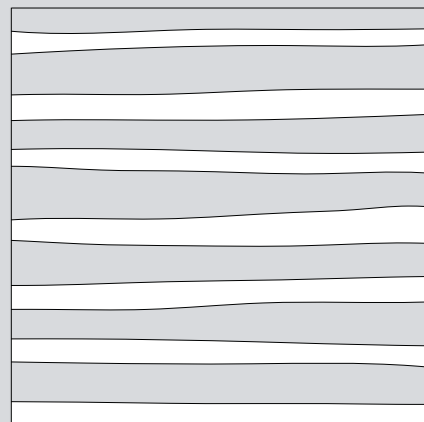

19

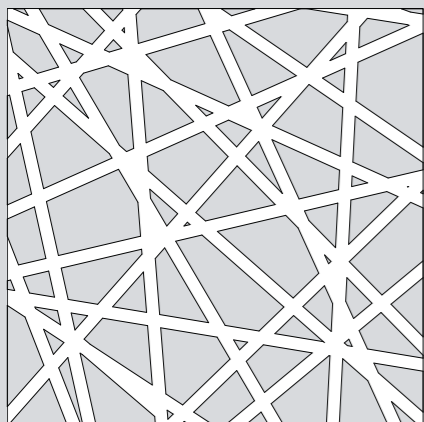

08

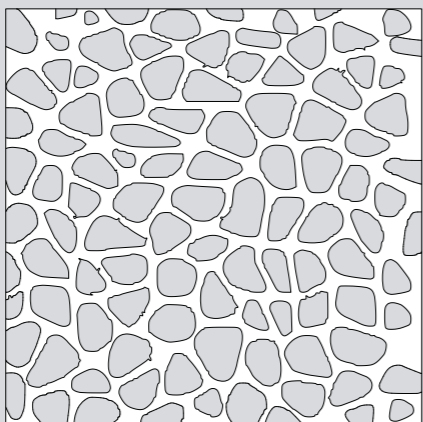

09

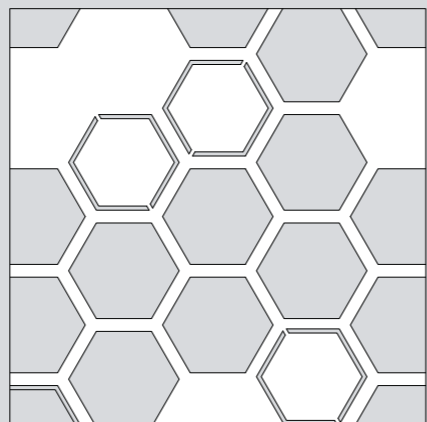

10

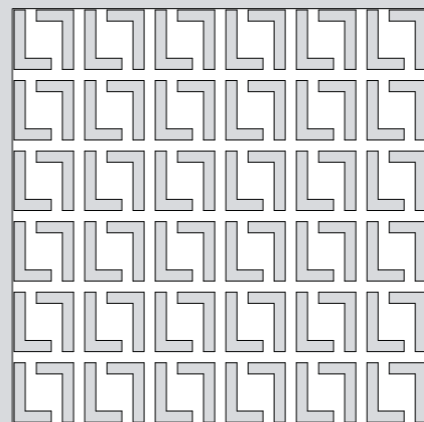

20

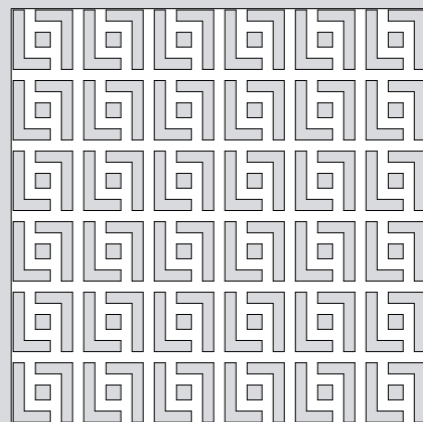

21

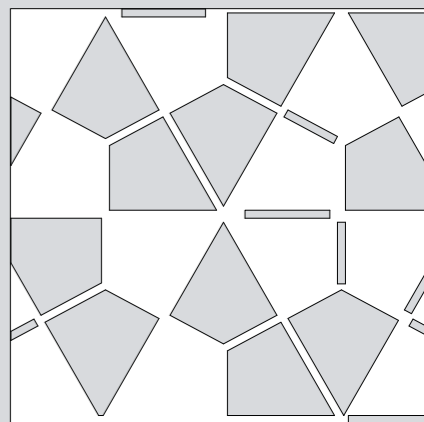

23

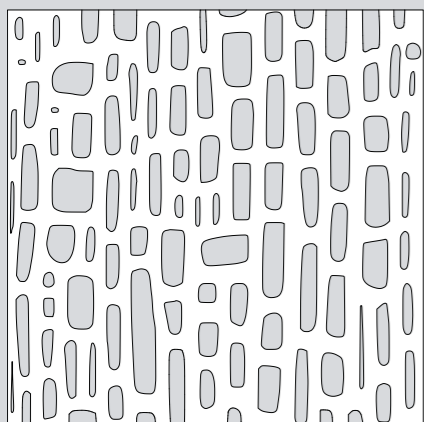

11

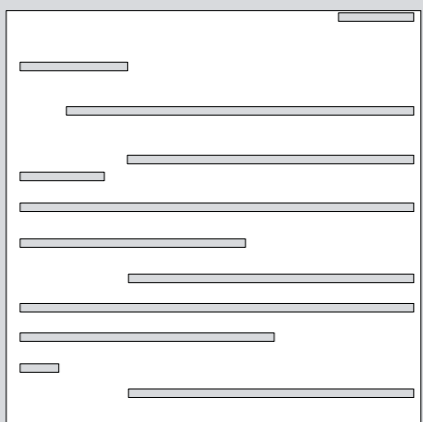

12

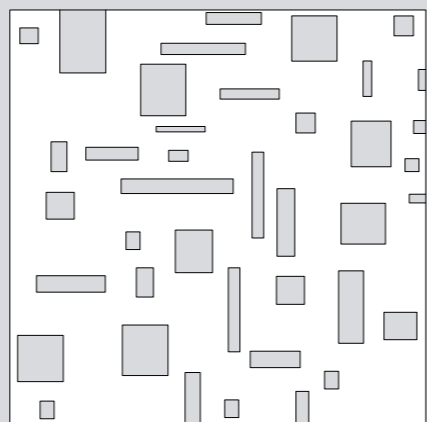

13

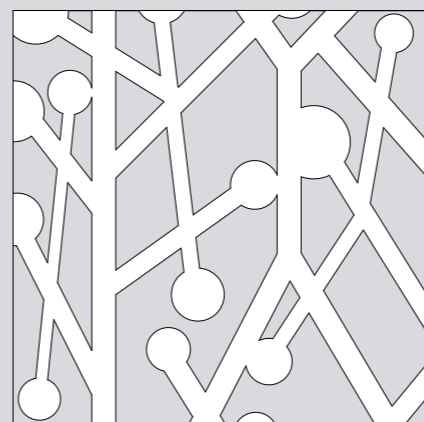

24

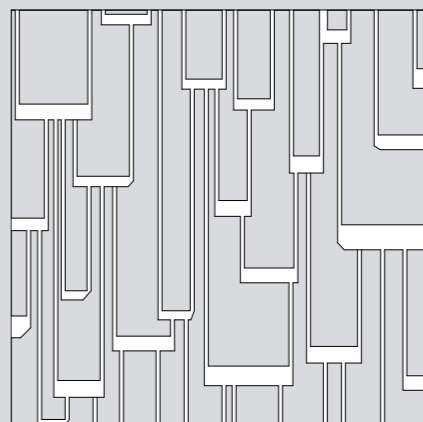

25

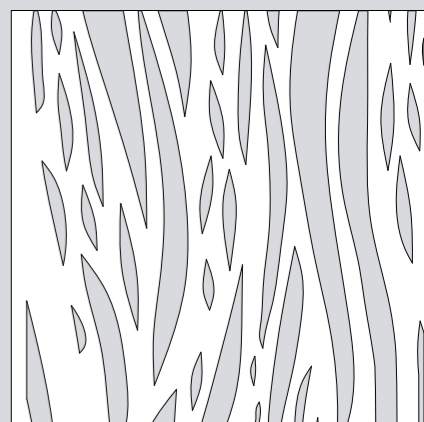

26